



DAIHATSU

MADE IN JAPAN

Rettungsdatenblätter für Rettungskräfte



Übersicht Rettungsdatenblätter

Modell	Ausführung	Amtlicher Typ	Bauzeitraum	Seite
APPLAUSE	A101	A1	1998-2001	03
CHARADE	G200, G201, G204./.	G2	1996-2001	04
	G204./.	G2	1996-2001	05
	G200, G204./.	G2	1996-2001	06
CHARADE	NSP 90 LCH	NSP 90	03/2011	07
CUORE	L501 / 3-Türer	L5	1995-1998	08
	L501 / 5-Türer	L5	1995-1998	09
CUORE	L701 / 3-Türer	L7	1998-2003	10
	L701 / 5-Türer	L7	1998-2003	11
CUORE	L251./.	L2	2003-2006	12
	L251./.	L2	2003-2006	13
CUORE	L276	L27	ab 2007	14
COPEN	L880	L8	2003-2006	15
COPEN	L881	L8	ab 2006	16
GRAN MOVE	G303 / G301	G3	1998-2003	17
MATERIA	M401, M402, M412	M4	ab 2007	18
MOVE	L601, L901	L6/L9	1997-2003	19
SIRION	M100, M101, M110, M111	M1	1998-2005	20
SIRION	M300, M301, M303, M311	M3	ab 2005	21
TERIOS	J100, J102	J1	1997-2005	22
TERIOS	J200, J210	J2	ab 2006	23
TREVIS	L651	L651	2006-2009	24
YRV	M200, M201, M211	M2	2000-2005	25

Hinweis:

Diese Rettungsdatenblätter wurden ausschließlich für Rettungskräfte erteilt, die über eine spezielle Ausbildung auf dem Gebiet der technischen Hilfeleistung nach Verkehrsunfällen und der damit verbundenen Tätigkeiten verfügen. Ferner enthalten die Rettungsdatenblätter ausschließlich Informationen über Fahrzeuge, die zum Verkauf in Deutschland bestimmt sind.

Spezifikationen und Sonderausstattungen der DAIHATSU Fahrzeuge sowie das Fahrzeugangebot unterliegen stetig etwaigen Änderungen. Daher behält sich DAIHATSU inhaltliche Anpassungen bzw. Änderungen an den Rettungsdatenblättern jederzeit ausdrücklich vor.

Sie können die DAIHATSU-Rettungsdatenblätter direkt aus diesem PDF ausdrucken und in Ihrem Fahrzeug hinter der Fahrersonnenblende deponieren.

Die in diesem Leitfaden enthaltenen Informationen sind nicht für Endkunden und ebenfalls nicht für Werkstätten und Händler bestimmt. Endkunden können von Bordbüchern ihres jeweiligen Fahrzeuges detaillierte Informationen zu den Funktionen ihres Fahrzeuges sowie wichtige Sicherheitshinweise zur Fahrzeug- und Insassensicherheit entnehmen. Werkstätten und Händler erhalten Reparaturinformationen über die ihnen bekannten Bezugsquellen.

In den Rettungsdatenblättern ist immer die maximal mögliche Ausstattung der Fahrzeuge gezeigt.







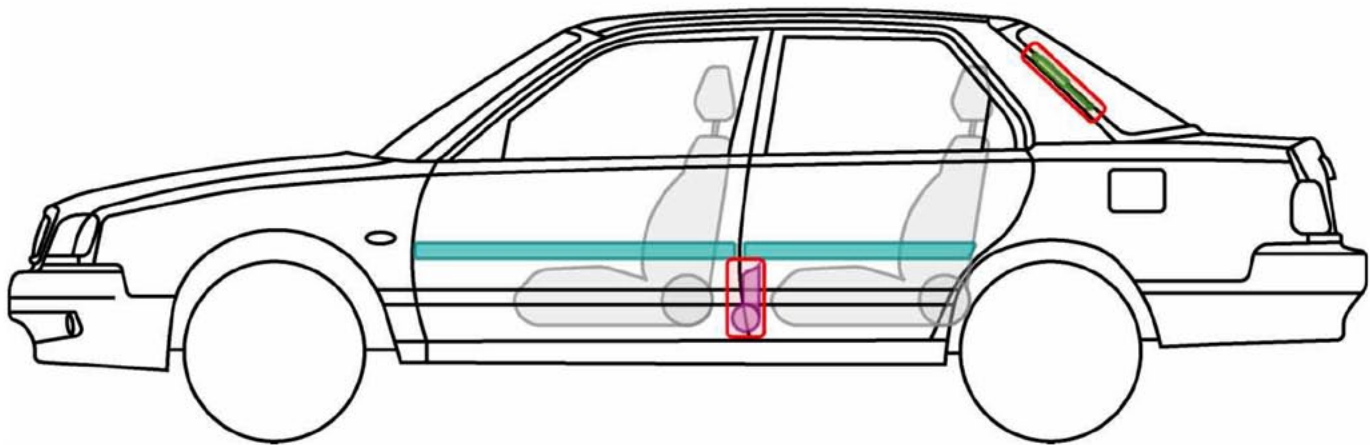
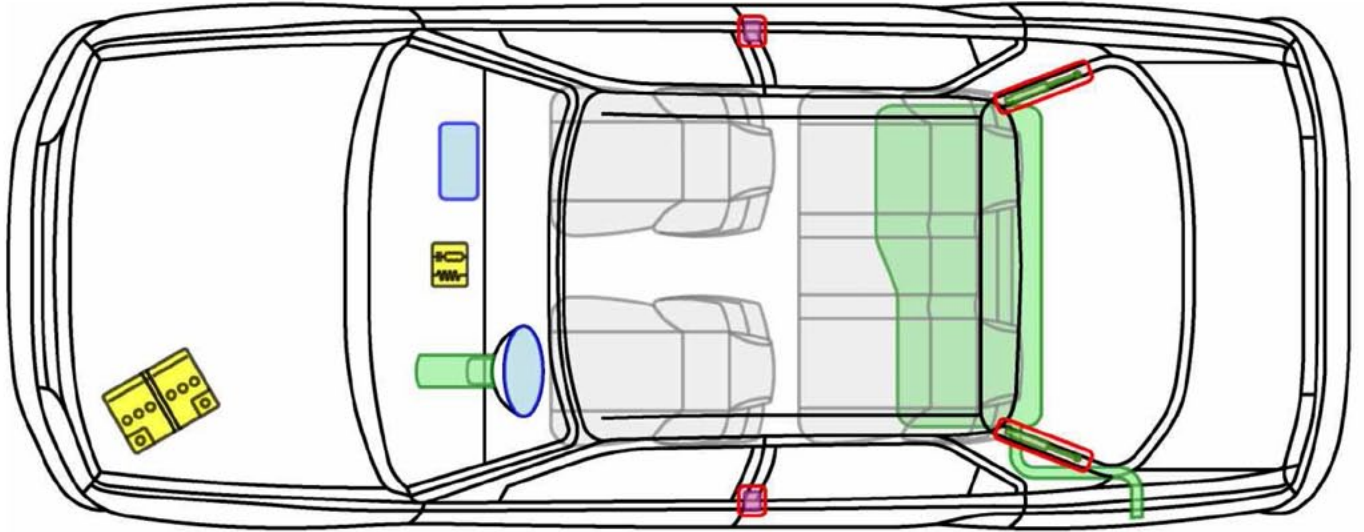

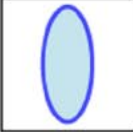

MADE IN JAPAN

APPLAUSE (A101) 1998-2001

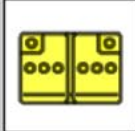

Legende

	Airbag		Karosserie- verstärkung		Steuergerät
	Gas- generator		Überroll- schutz		Batterie
	Gurt- straffer		Gasdruck- dämpfer		Kraftstoff- tank

Applause



CHARADE (G2) 1996-2001

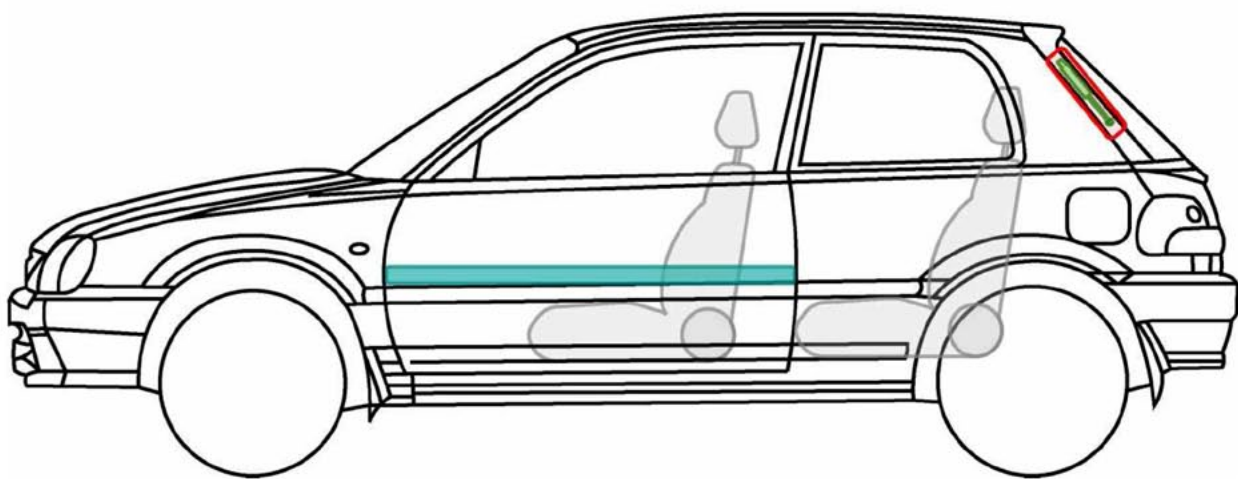
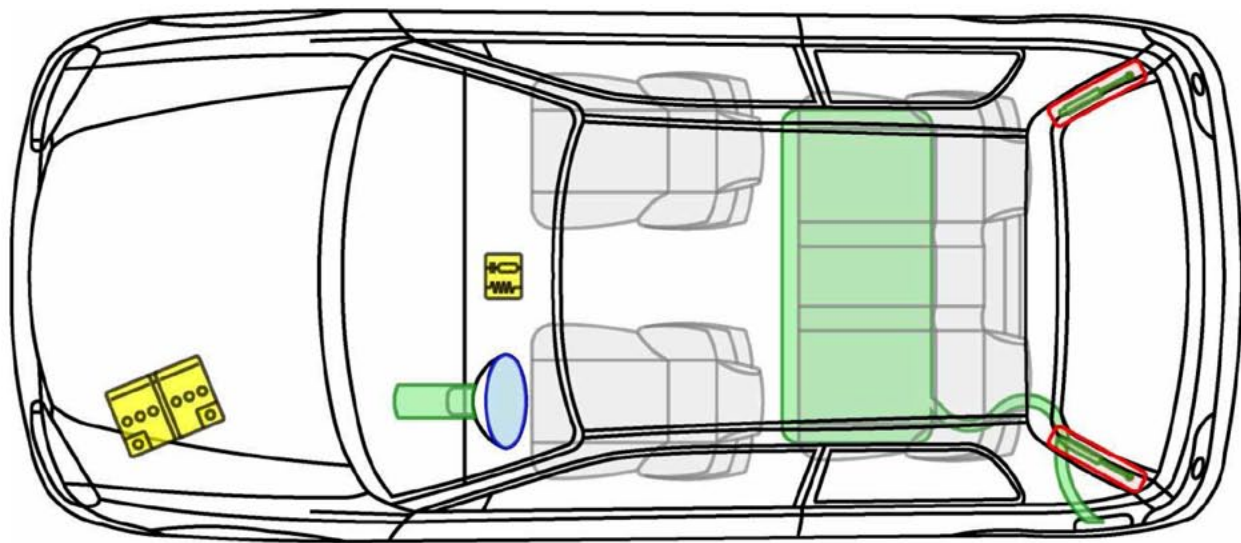

Legende

	Airbag		Karosserie- verstärkung		Steuergerät
	Gas- generator		Überroll- schutz		Batterie
	Gurt- straffer		Gasdruck- dämpfer		Kraftstoff- tank

Charade



CHARADE (G2) 1996-2001

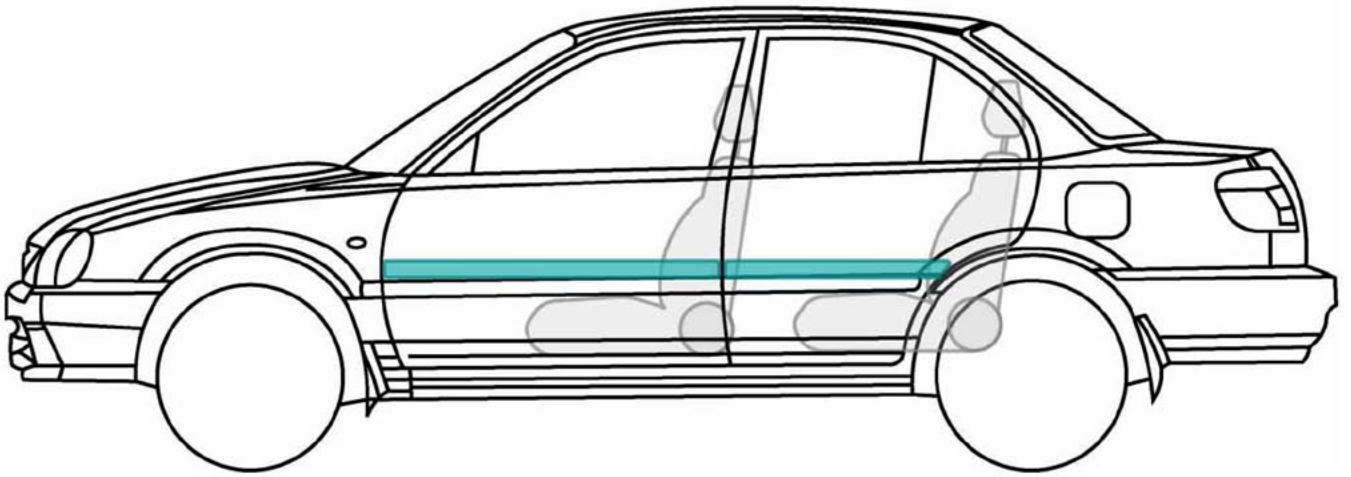
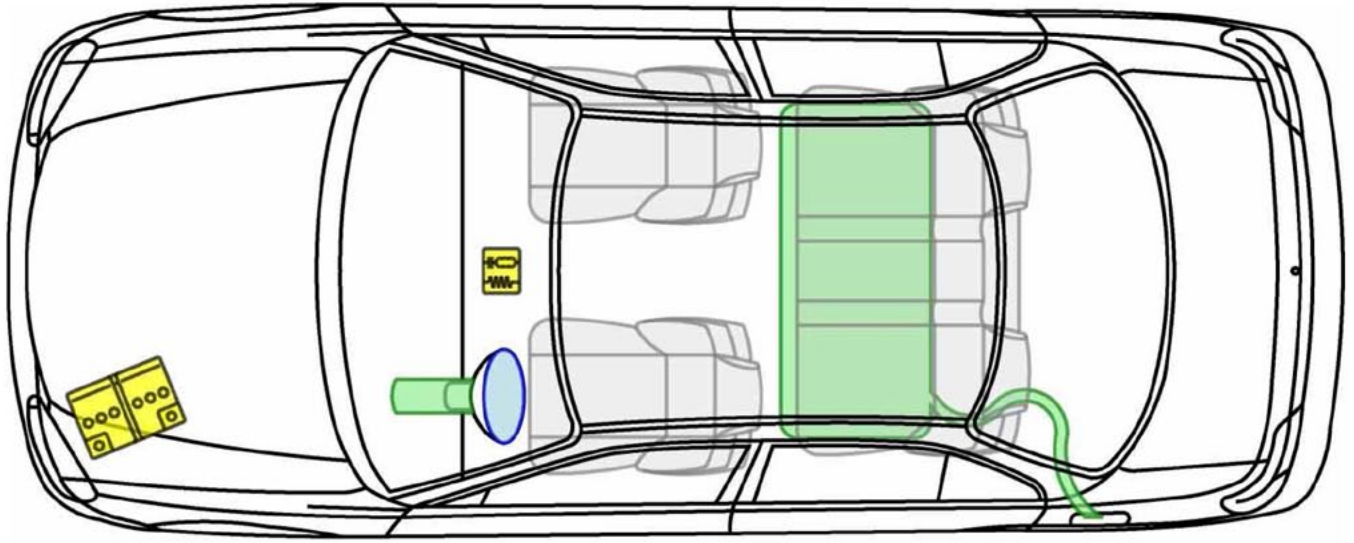

Legende







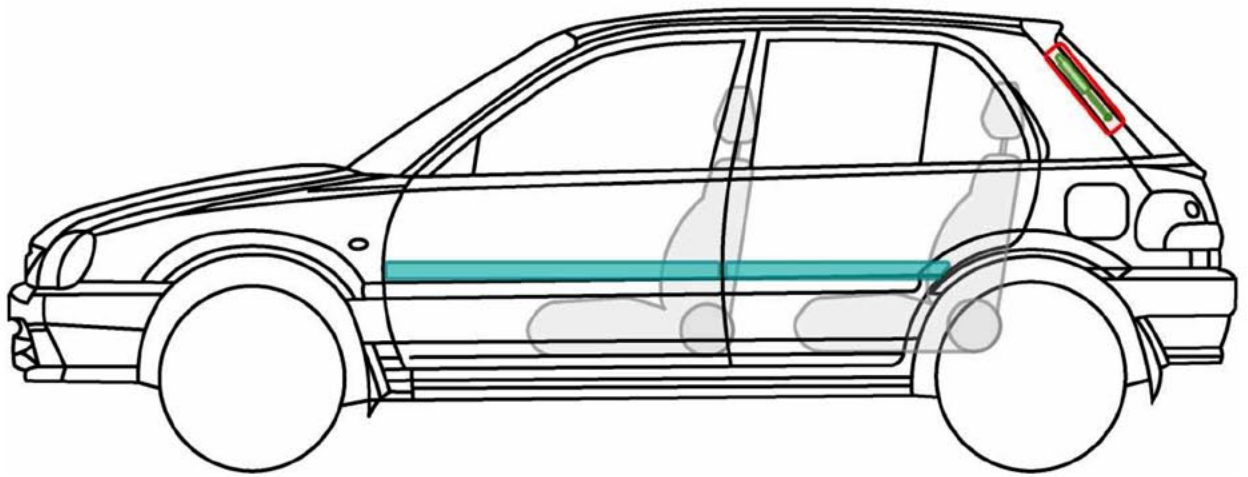
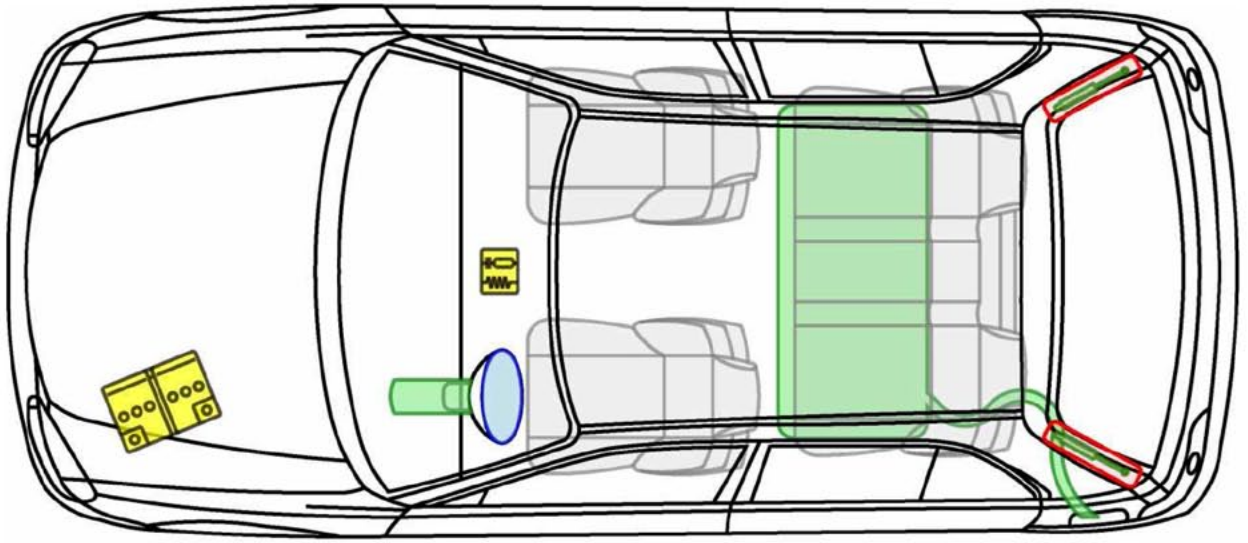

	Airbag		Karosserie-verstärkung		Steuergerät
	Gas-generator		Überroll-schutz		Batterie
	Gurt-straffer		Gasdruck-dämpfer		Kraftstoff-tank



CHARADE (G2) 1996-2001



Legende







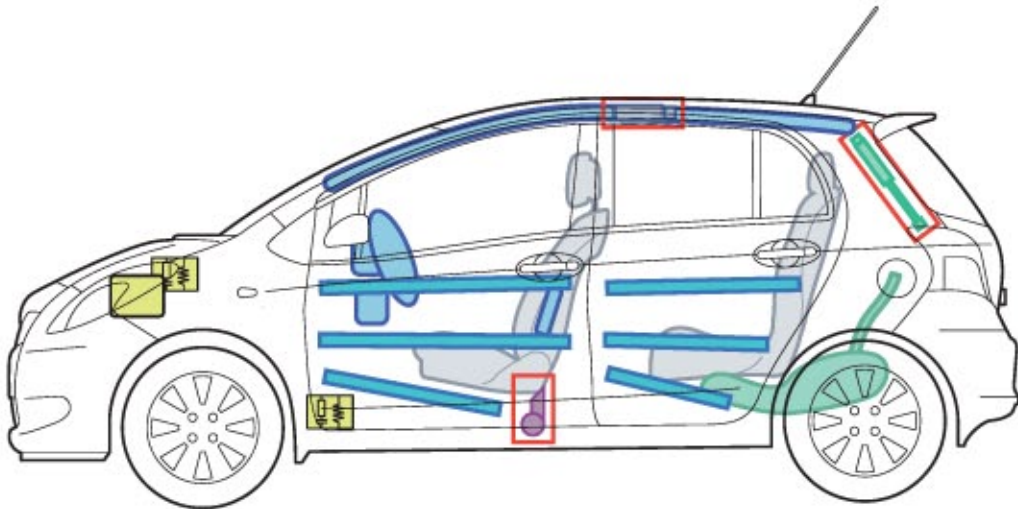
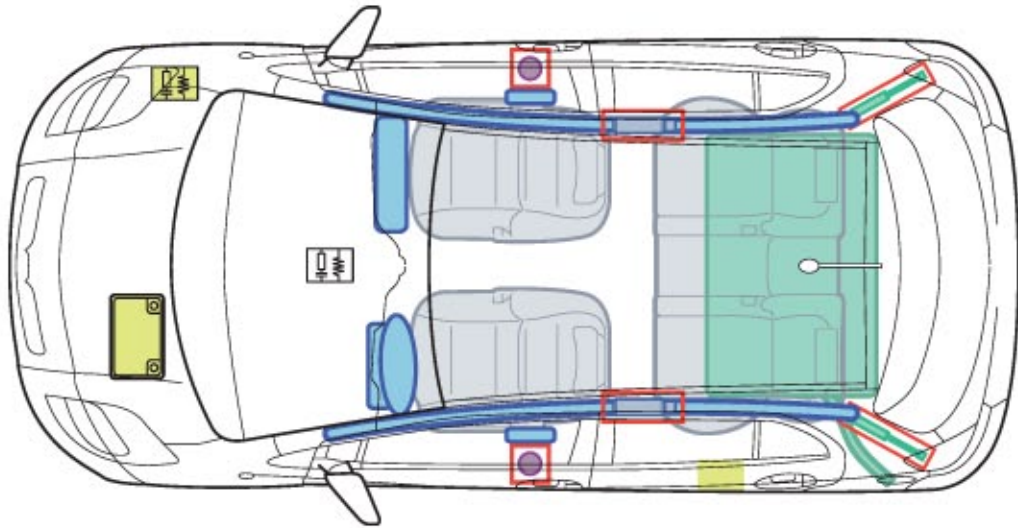

	Airbag		Karosserie- verstärkung		Steuergerät
	Gas- generator		Überroll- schutz		Batterie
	Gurt- straffer		Gasdruck- dämpfer		Kraftstoff- tank



CHARADE (NSP90) ab 03/2011



Legende

	Airbag		Karosserie- verstärkung		Steuergerät
	Gas- generator		Gasdruck- dämpfer		12 Volt- Batterie
	Gurtstraffer		Kraftstoff- tank		



CUORE (L501) 1995-1998

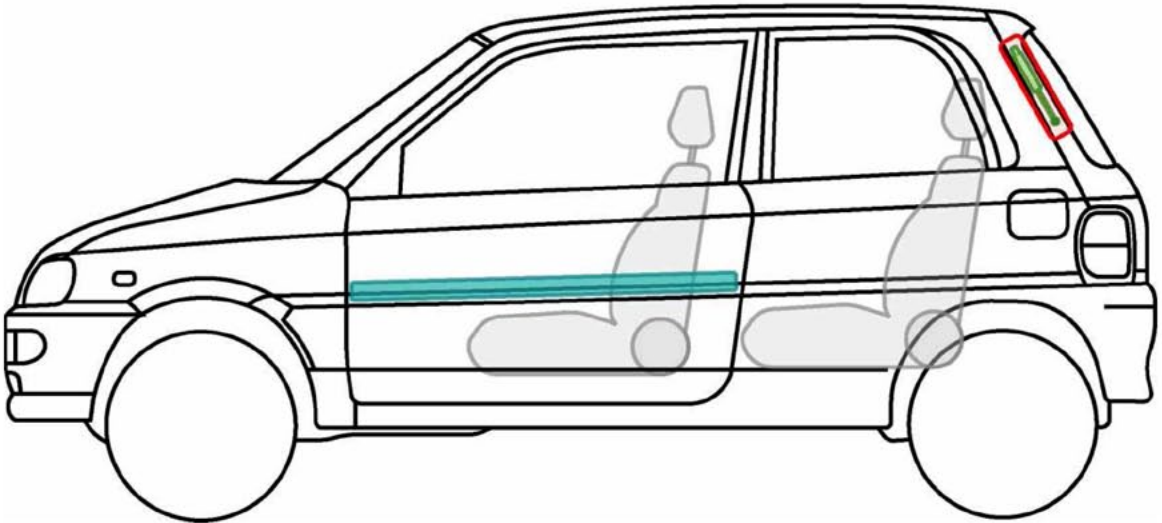
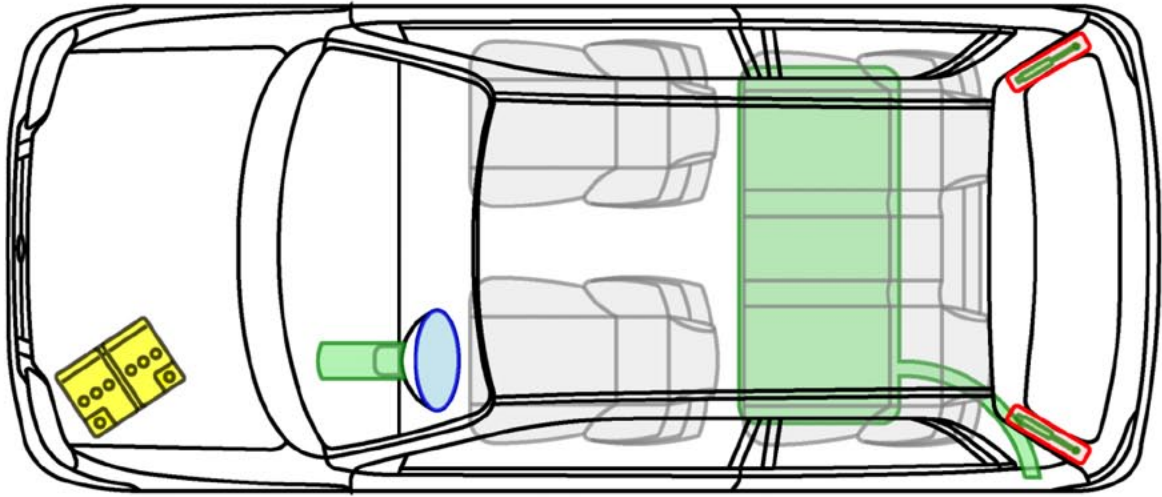

Legende

	Airbag		Karosserie- verstärkung		Steuergerät
	Gas- generator		Überroll- schutz		Batterie
	Gurt- straffer		Gasdruck- dämpfer		Kraftstoff- tank

Cuore



CUORE (L501) 1995-1998

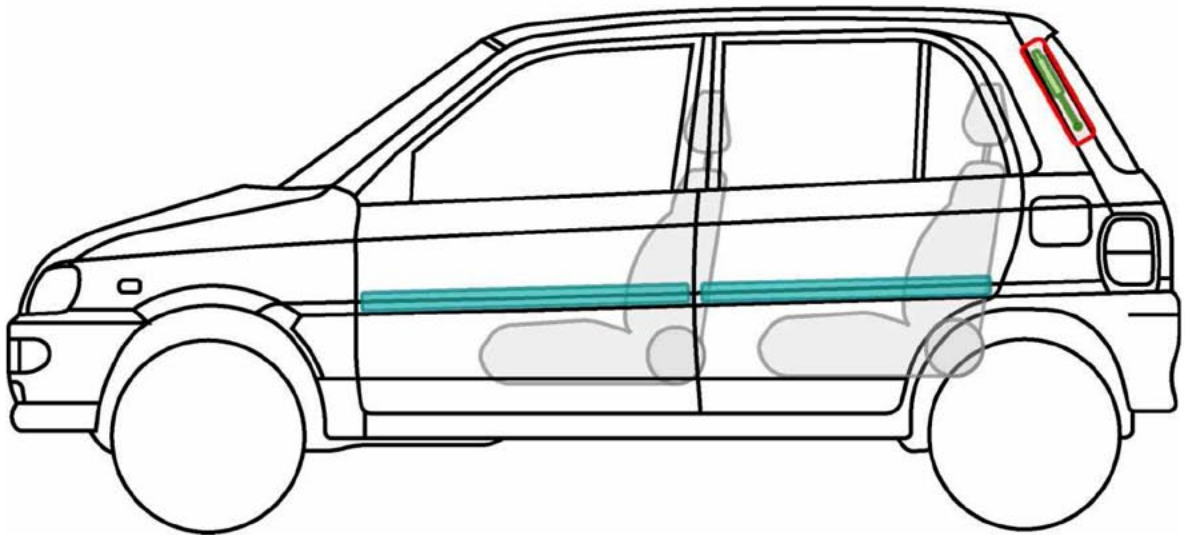
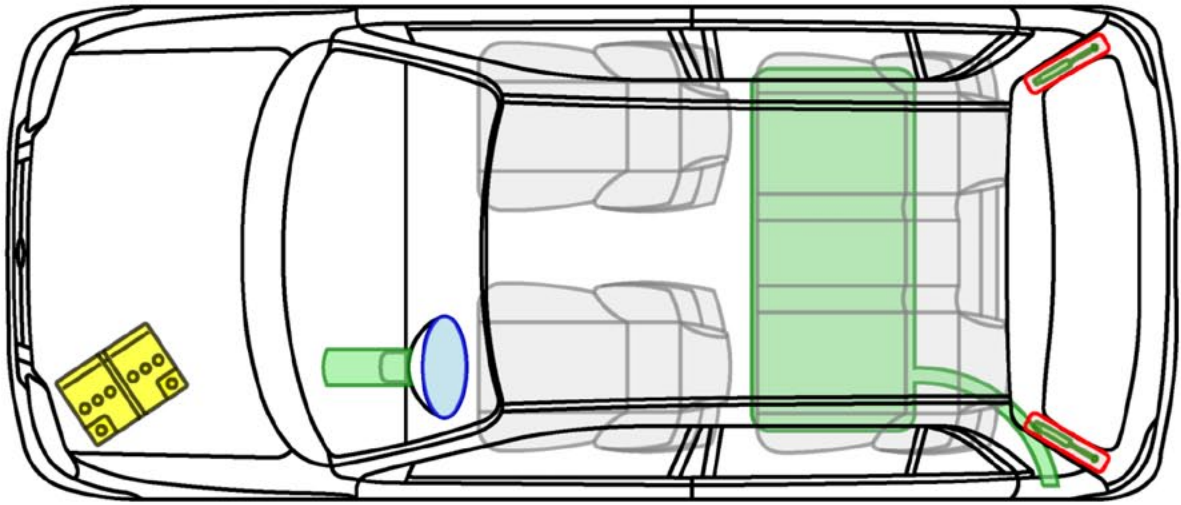

Legende

	Airbag		Karosserie-verstärkung		Steuergerät
	Gas-generator		Überroll-schutz		Batterie
	Gurt-straffer		Gasdruck-dämpfer		Kraftstoff-tank

Cuore









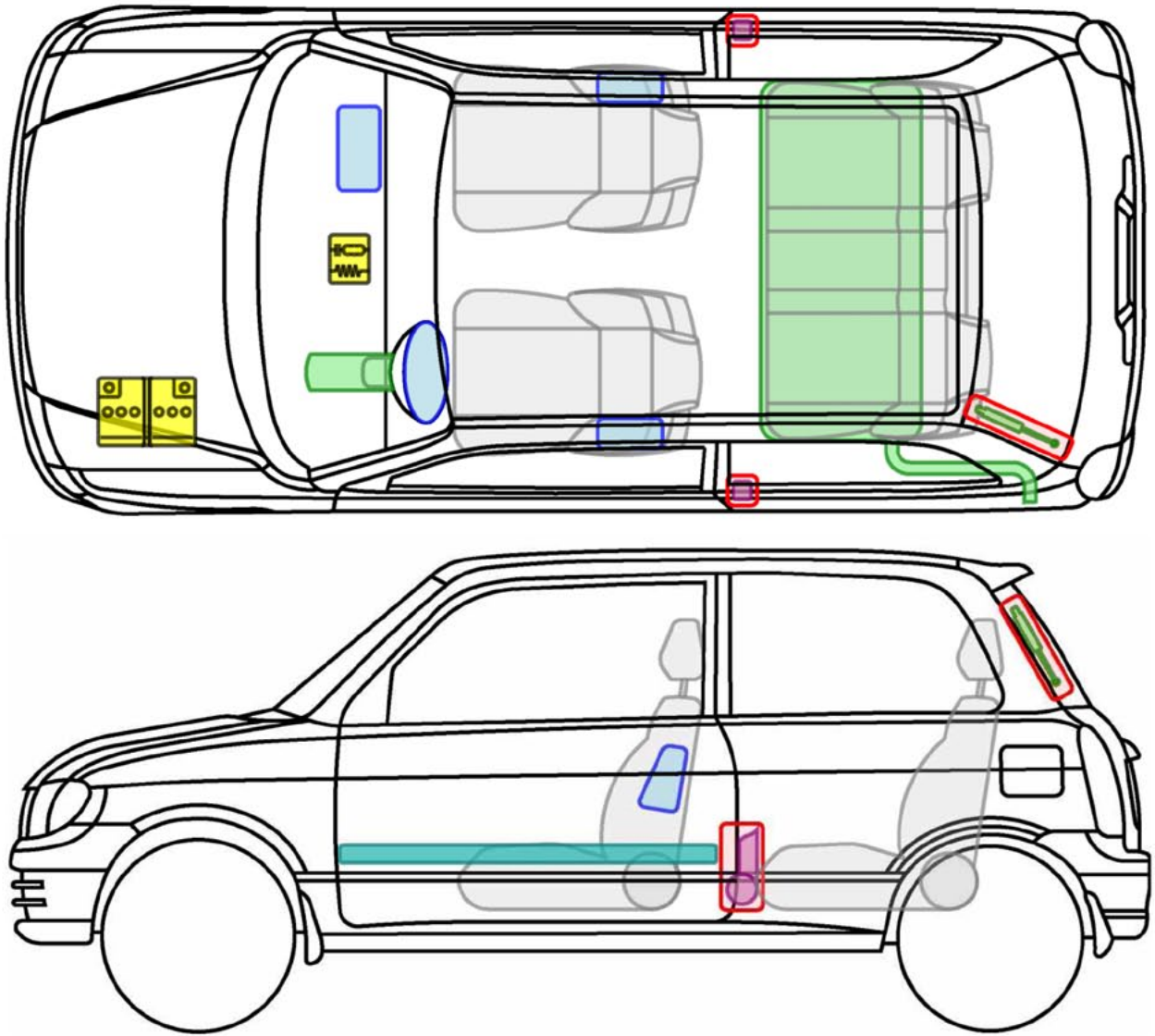

DAIHATSU

MADE IN JAPAN

CUORE (L7) 1998-2003

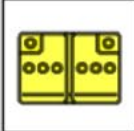

Legende

	Airbag		Karosserie- verstärkung		Steuergerät
	Gas- generator		Überroll- schutz		Batterie
	Gurt- straffer		Gasdruck- dämpfer		Kraftstoff- tank

Cuore



DAIHATSU

MADE IN JAPAN

CUORE (L7) 1998-2003

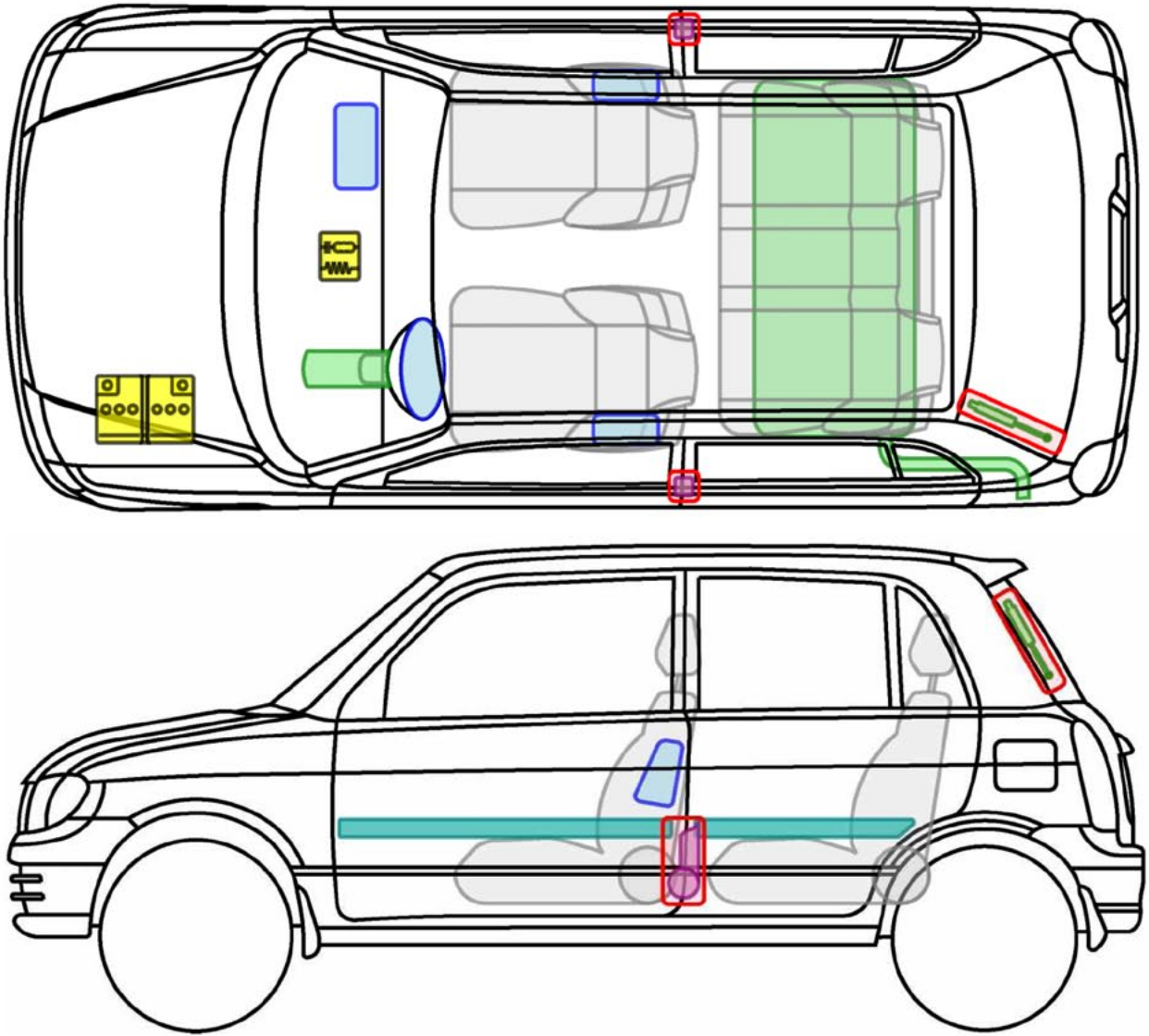

Legende

	Airbag		Karosserie- verstärkung		Steuergerät
	Gas- generator		Überroll- schutz		Batterie
	Gurt- straffer		Gasdruck- dämpfer		Kraftstoff- tank

Cuore







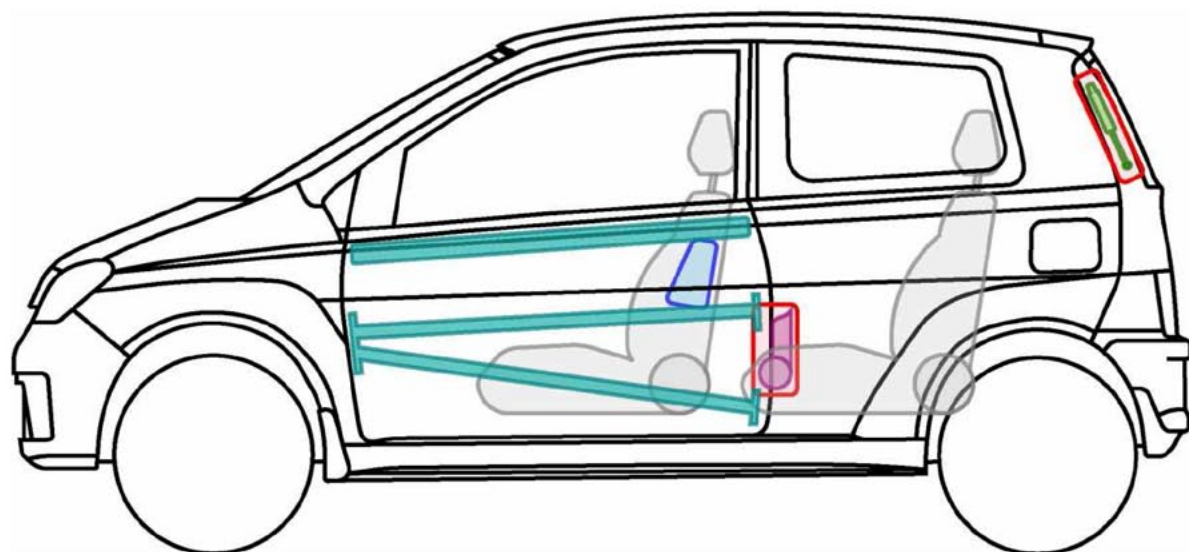
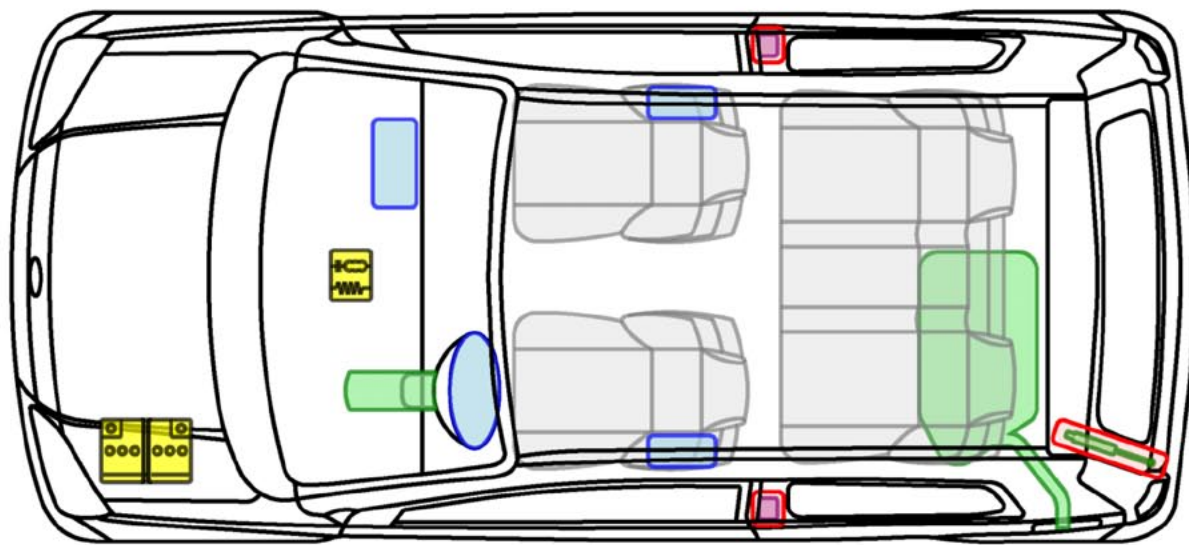

DAIHATSU

MADE IN JAPAN

CUORE (L251) 2003-2006

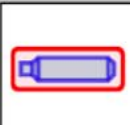

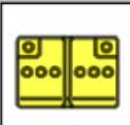
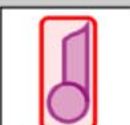
Legende

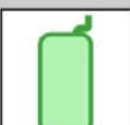
	Airbag		Karosserie- verstärkung		Steuergerät
	Gas- generator		Überroll- schutz		Batterie
	Gurt- straffer		Gasdruck- dämpfer		Kraftstoff- tank

Cuore



DAIHATSU

MADE IN JAPAN

CUORE (L251) 2003-2006

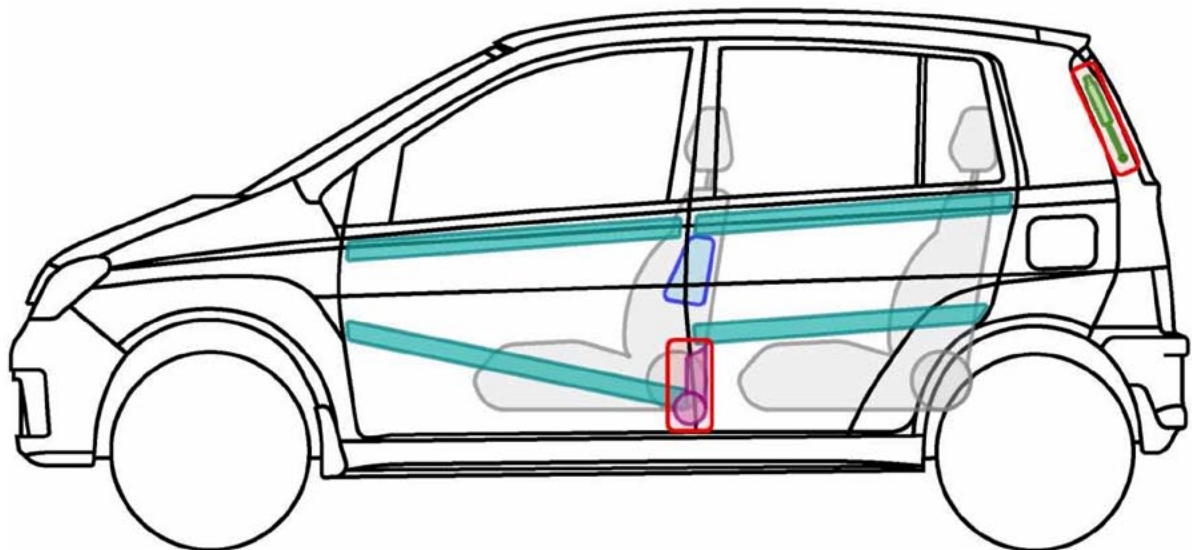
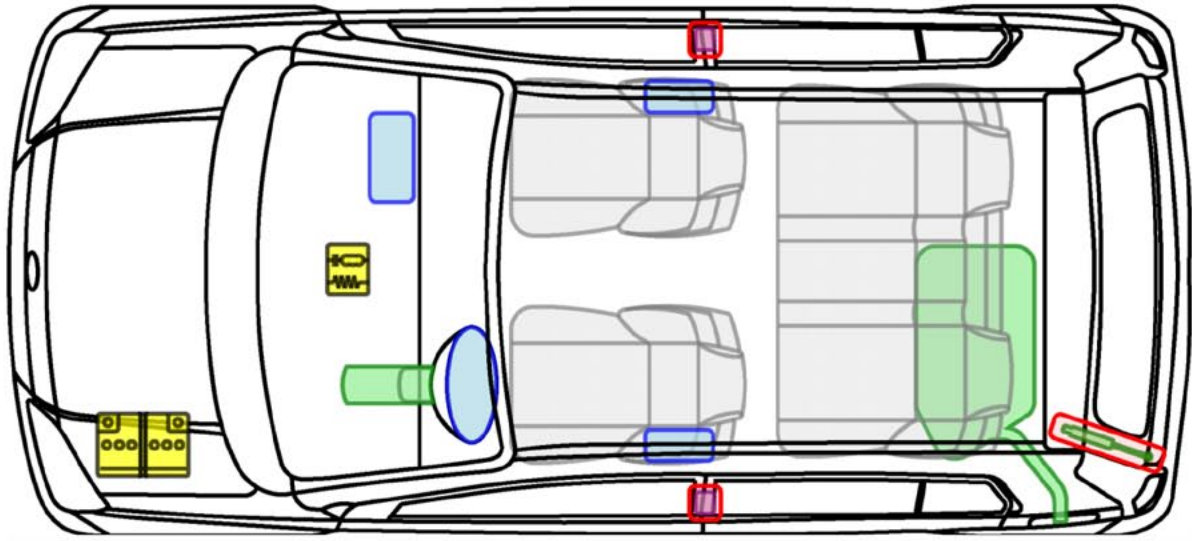

Legende

	Airbag		Karosserie-verstärkung		Steuergerät
	Gas-generator		Überroll-schutz		Batterie
	Gurt-straffer		Gasdruck-dämpfer		Kraftstoff-tank

Cuore









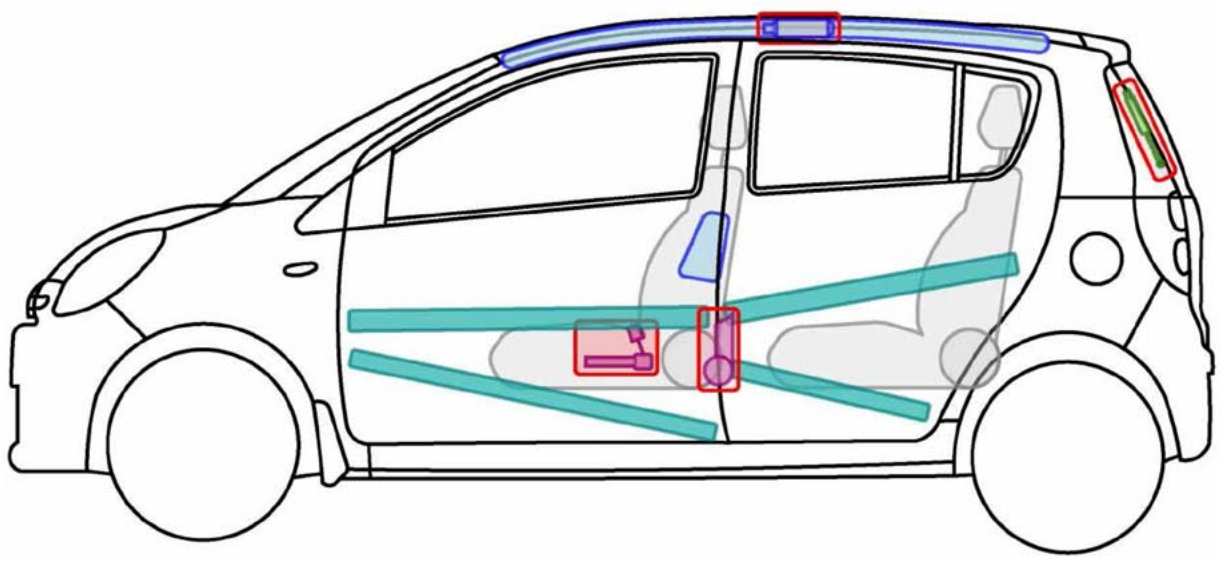
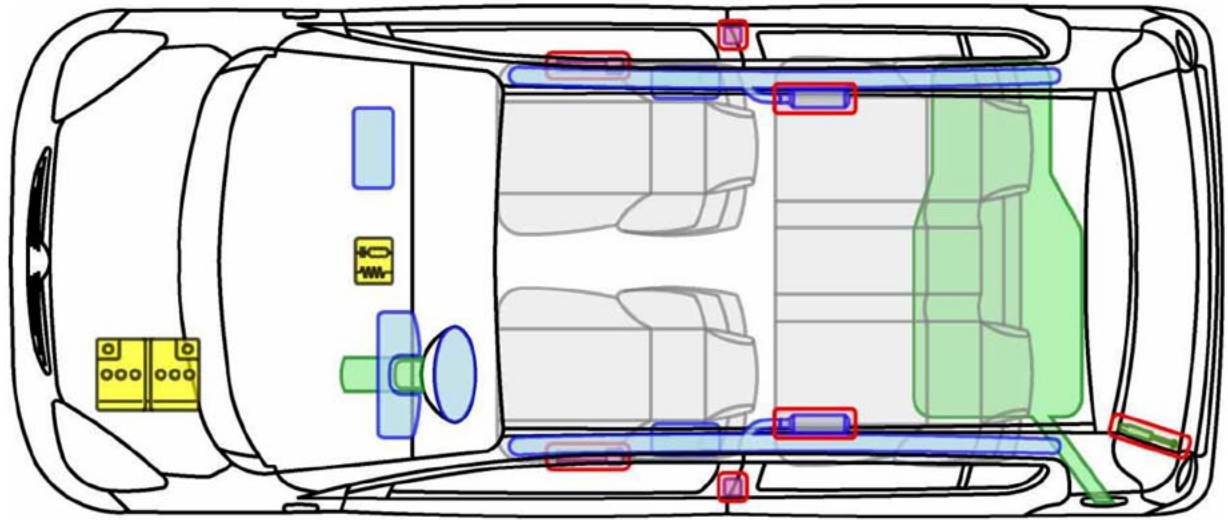

DAIHATSU

MADE IN JAPAN

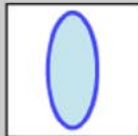
CUORE (L276) ab 2007

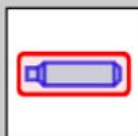

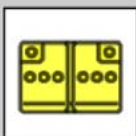
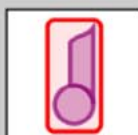
Legende

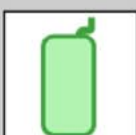
	Airbag		Karosserie-verstärkung		Steuergerät
	Gas-generator		Überroll-schutz		Batterie
	Gurt-straffer		Gasdruck-dämpfer		Kraftstoff-tank

Cuore











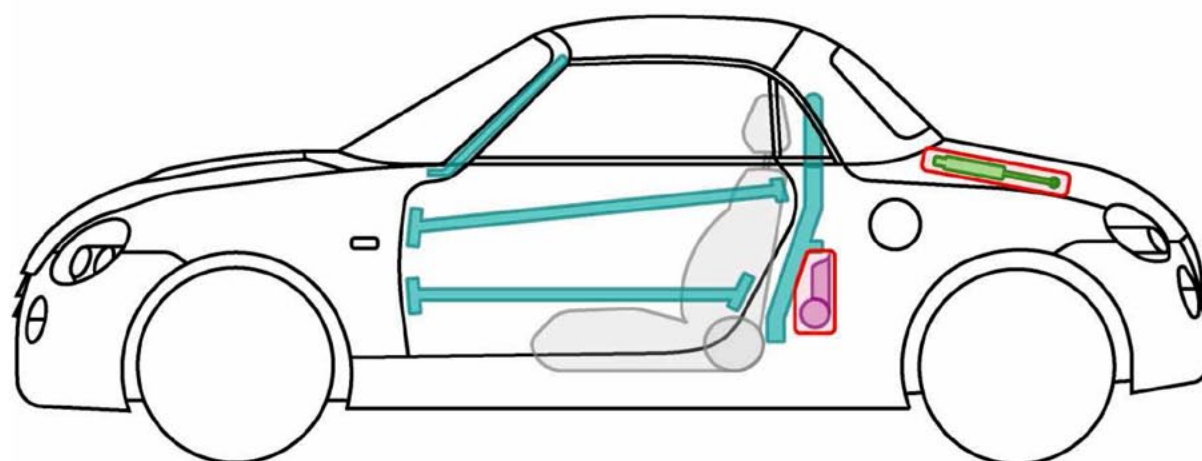
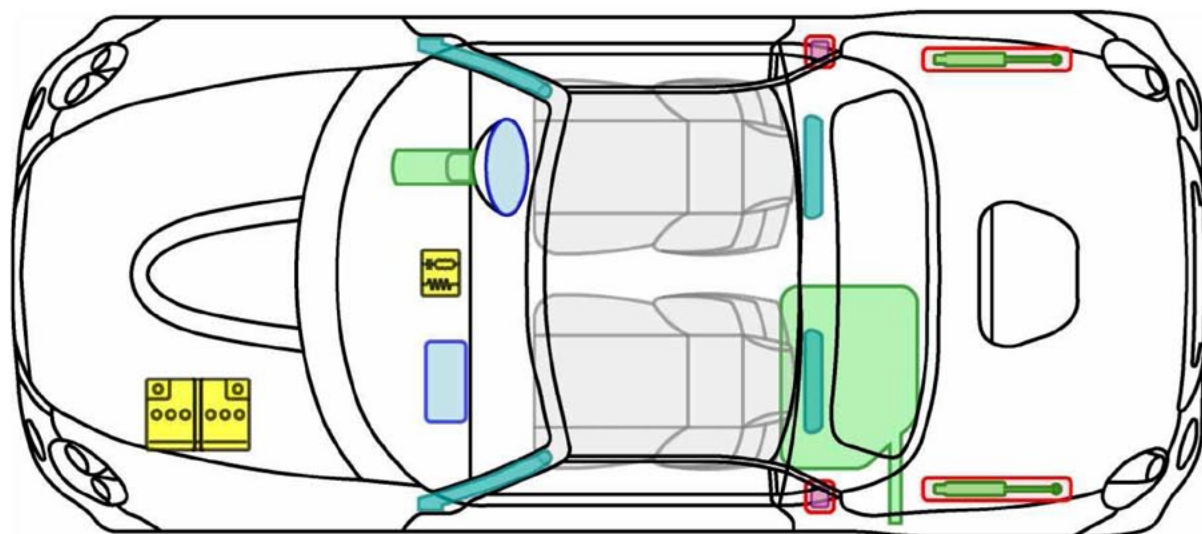

DAIHATSU

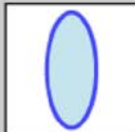
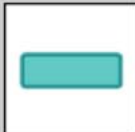
MADE IN JAPAN

COPEN (L880) 2004-2006

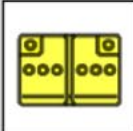

Legende

	Airbag		Karosserie- verstärkung		Steuergerät
	Gas- generator		Überroll- schutz		Batterie
	Gurt- straffer		Gasdruck- dämpfer		Kraftstoff- tank

Copen









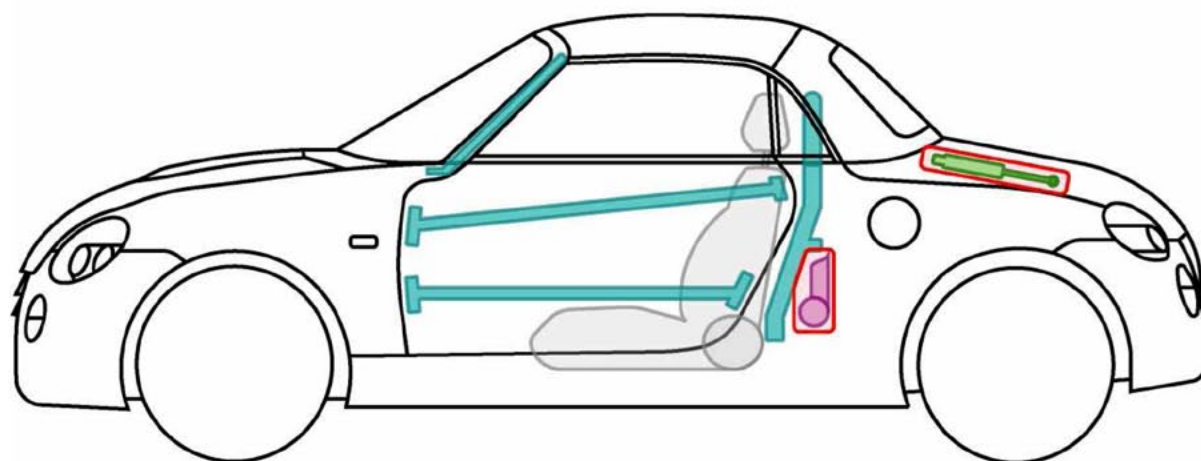
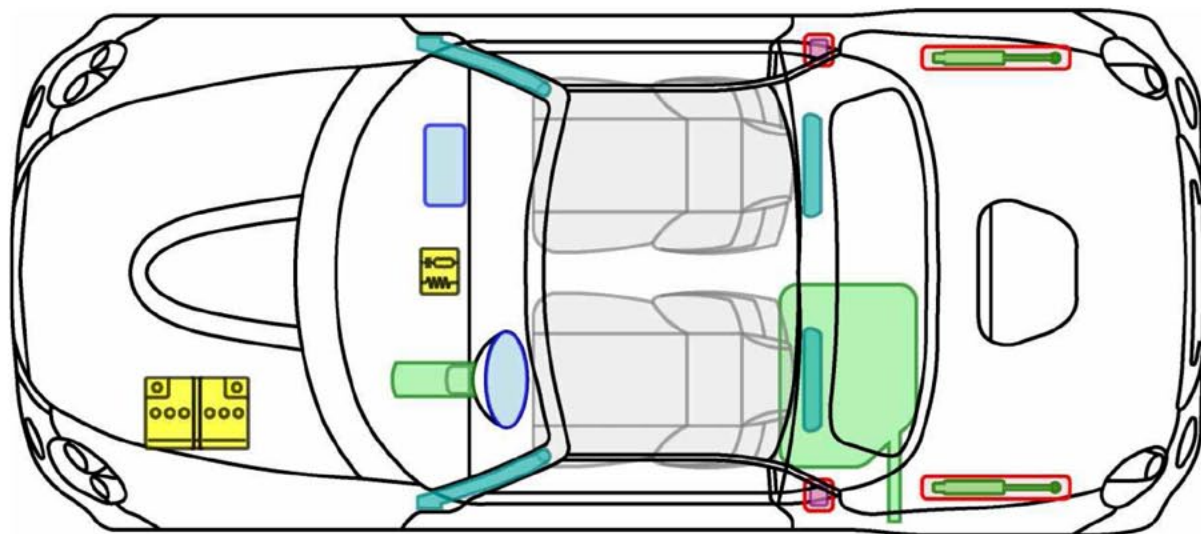

DAIHATSU

MADE IN JAPAN

COPEN (L881) ab 2006

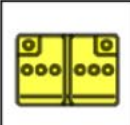

Legende

	Airbag		Karosserie- verstärkung		Steuergerät
	Gas- generator		Überroll- schutz		Batterie
	Gurt- straffer		Gasdruck- dämpfer		Kraftstoff- tank

Copen



GRAN MOVE (G3) 1998-2003

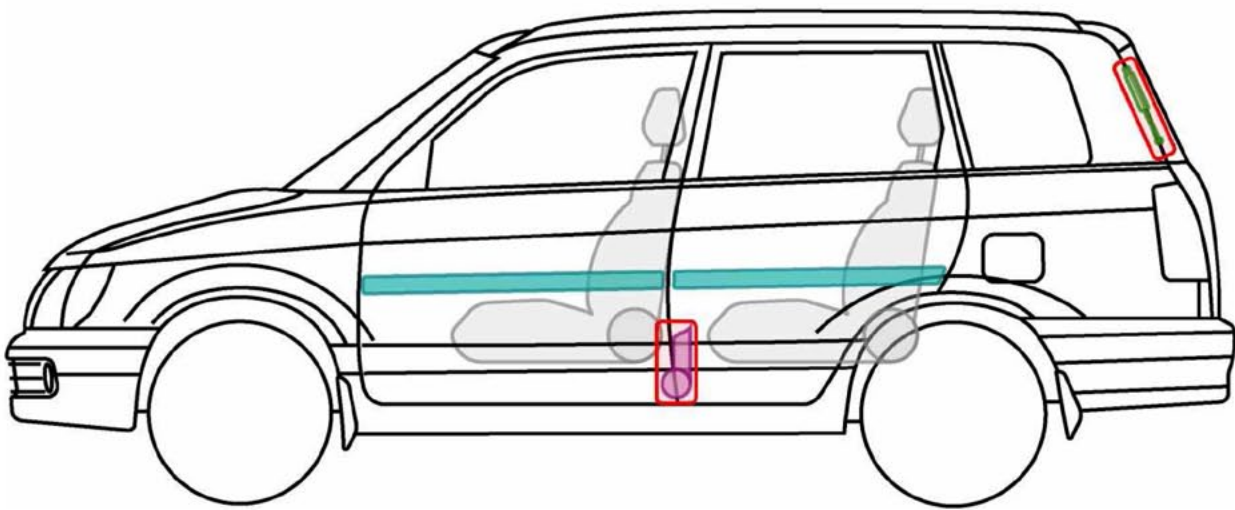
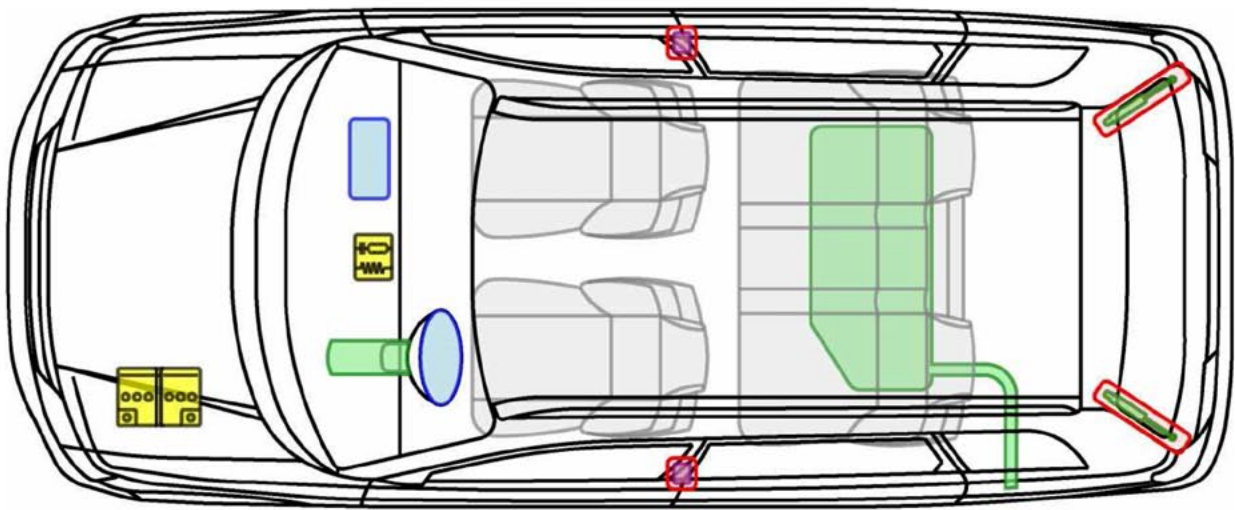

Legende

	Airbag		Karosserie-verstärkung		Steuergerät
	Gas-generator		Überroll-schutz		Batterie
	Gurt-straffer		Gasdruck-dämpfer		Kraftstoff-tank

Gran Move



DAIHATSU

MADE IN JAPAN

MATERIA (M4) ab 2007

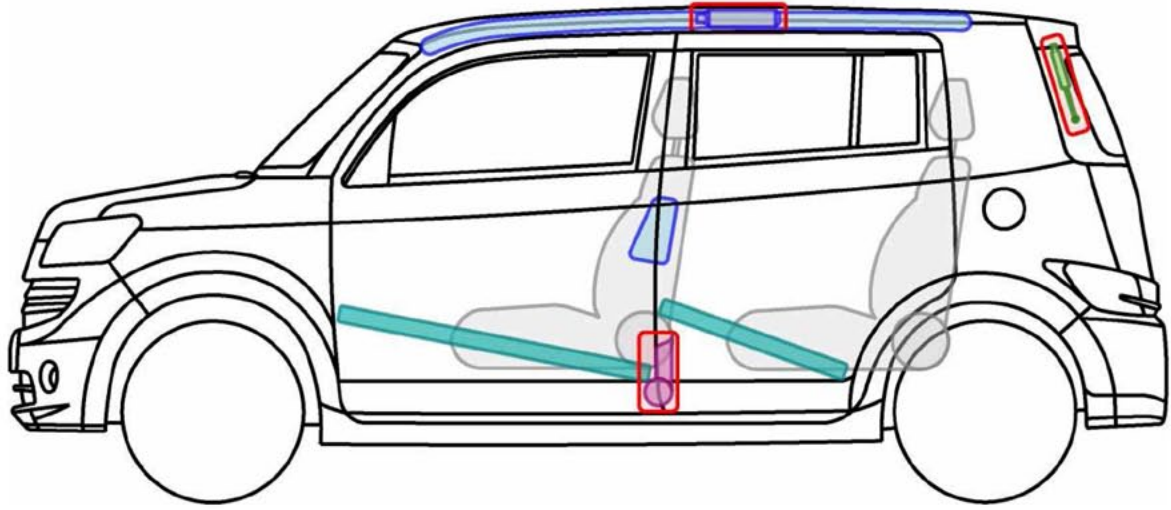
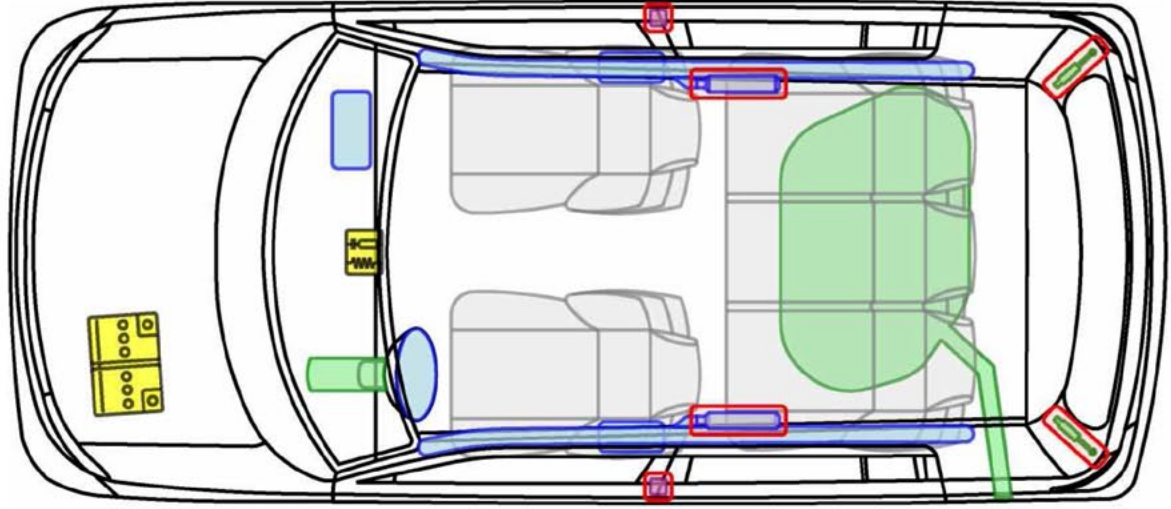

Legende

	Airbag		Karosserie-verstärkung		Steuergerät
	Gas-generator		Überroll-schutz		Batterie
	Gurt-straffer		Gasdruck-dämpfer		Kraftstoff-tank

Materia





MOVE (L6/L9) 1997-2003

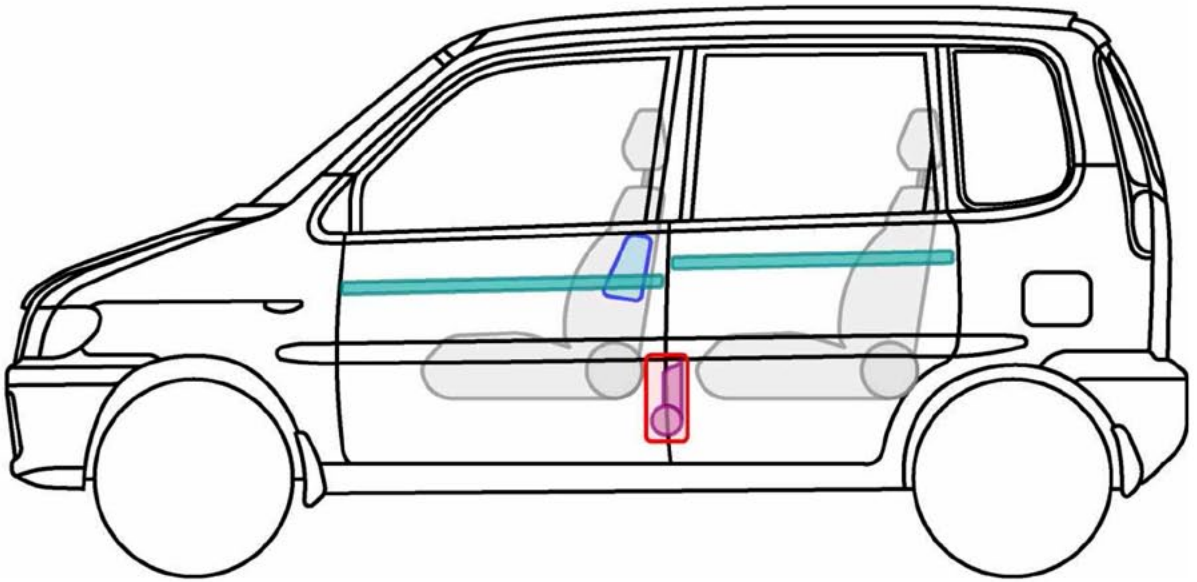
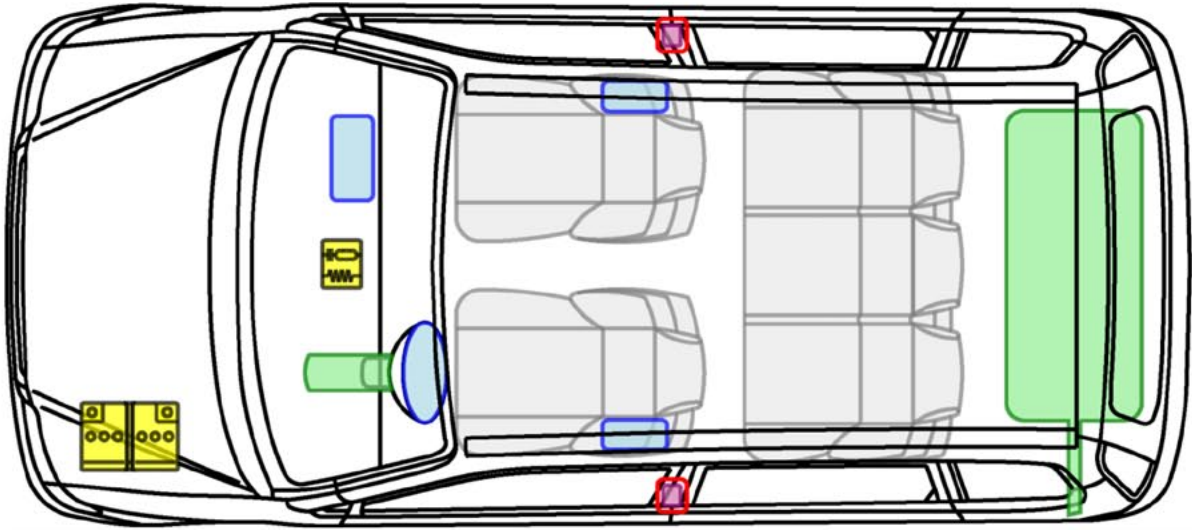

Legende

	Airbag		Karosserie-verstärkung		Steuergerät
	Gas-generator		Überroll-schutz		Batterie
	Gurt-straffer		Gasdruck-dämpfer		Kraftstoff-tank



DAIHATSU

MADE IN JAPAN

SIRION (M1) 1998-2005

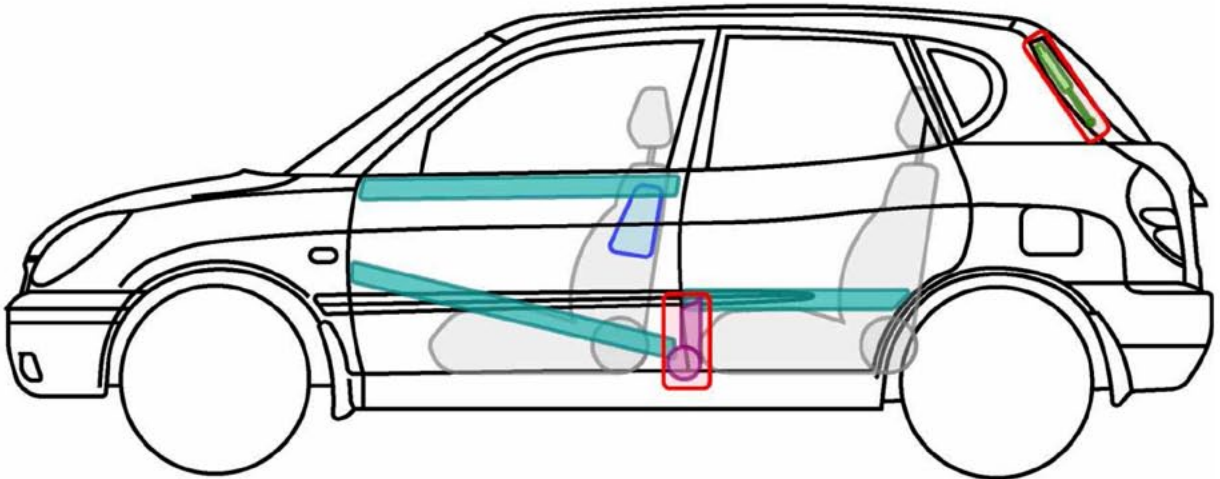
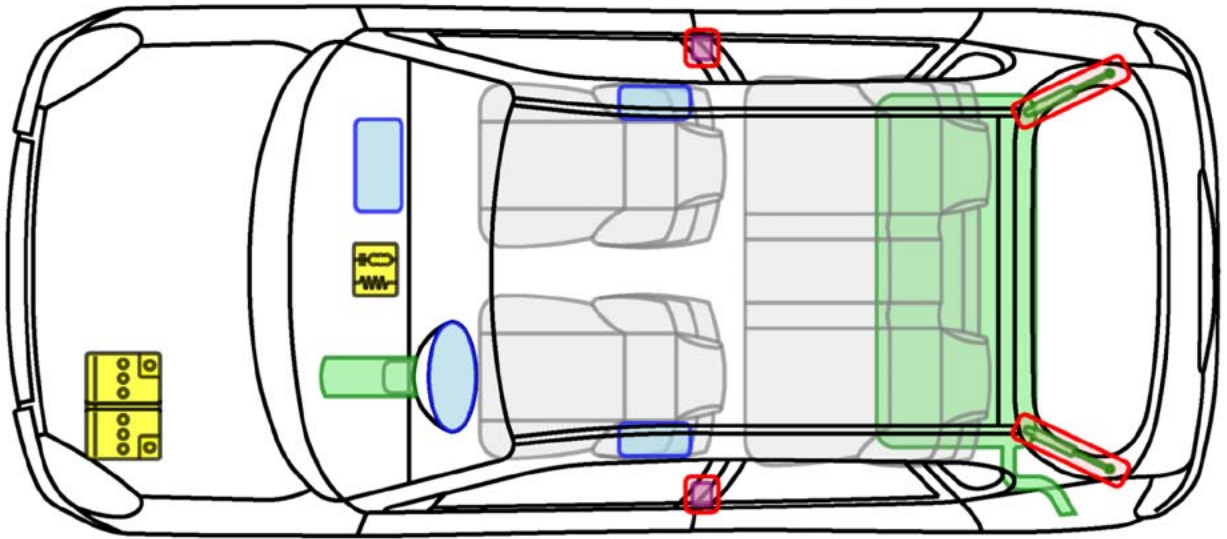

Legende

	Airbag		Karosserie- verstärkung		Steuergerät
	Gas- generator		Überroll- schutz		Batterie
	Gurt- straffer		Gasdruck- dämpfer		Kraftstoff- tank

Sirion







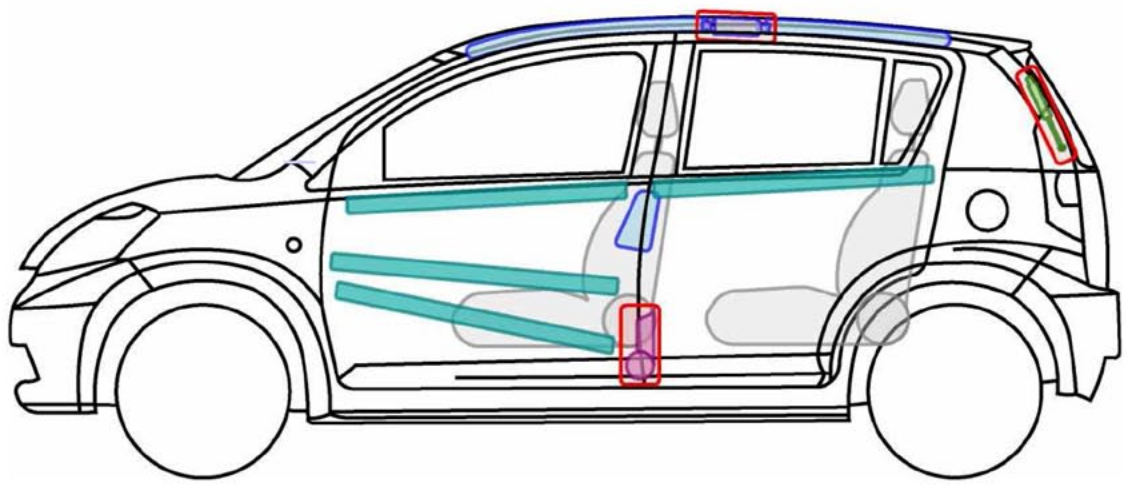
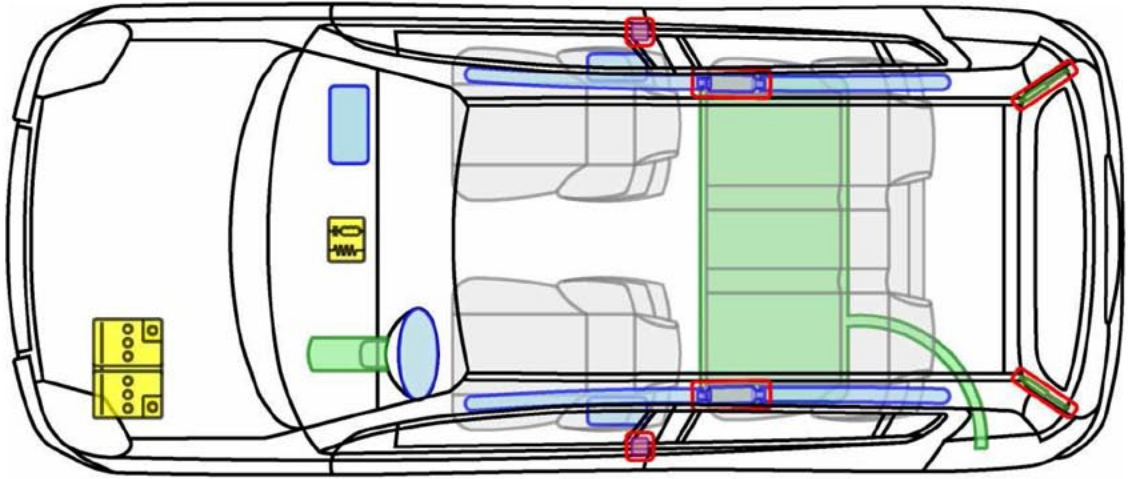

DAIHATSU

MADE IN JAPAN

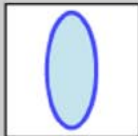
SIRION (M3) ab 2005

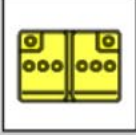
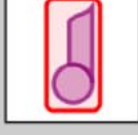
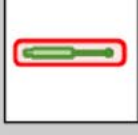

Legende

	Airbag		Karosserie- verstärkung		Steuergerät
	Gas- generator		Überroll- schutz		Batterie
	Gurt- straffer		Gasdruck- dämpfer		Kraftstoff- tank

Sirion



DAIHATSU

MADE IN JAPAN

TERIOS (J1) 1997-2005

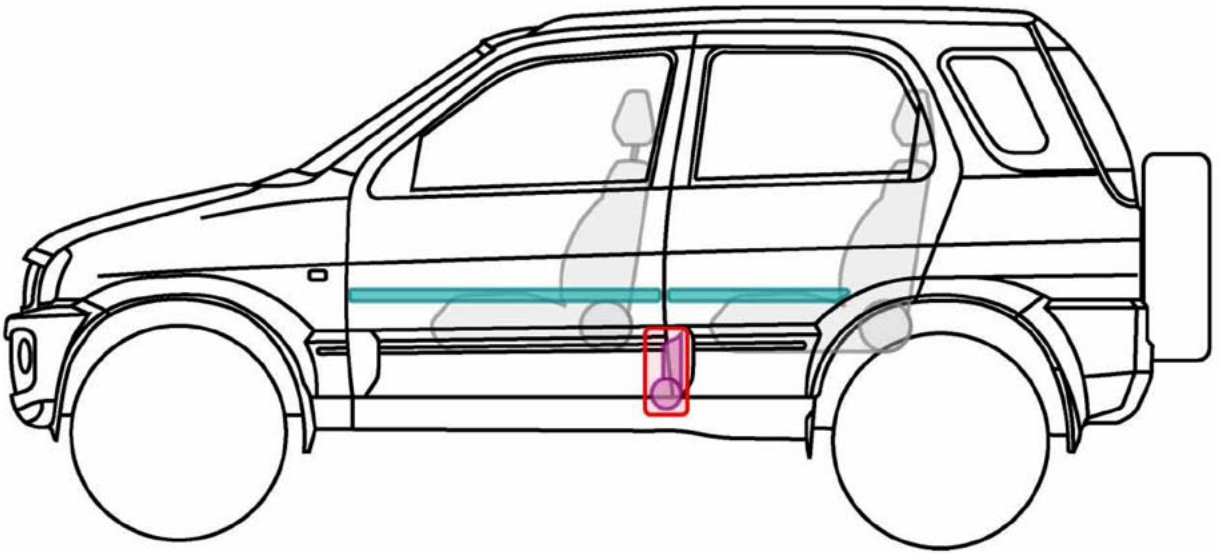
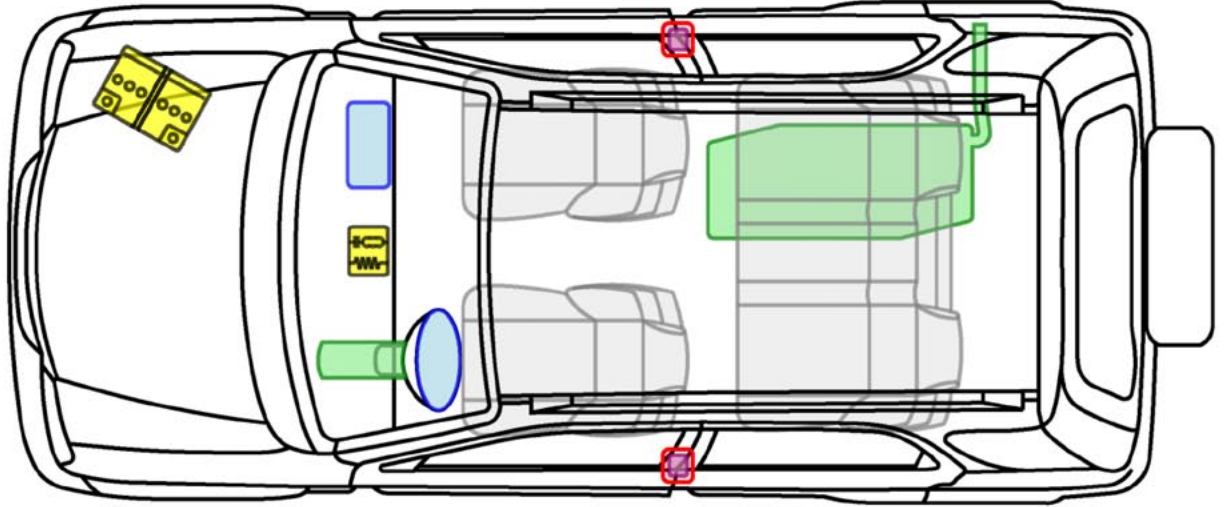

Legende

	Airbag		Karosserie-verstärkung		Steuergerät
	Gas-generator		Überroll-schutz		Batterie
	Gurt-straffer		Gasdruck-dämpfer		Kraftstoff-tank

Terios









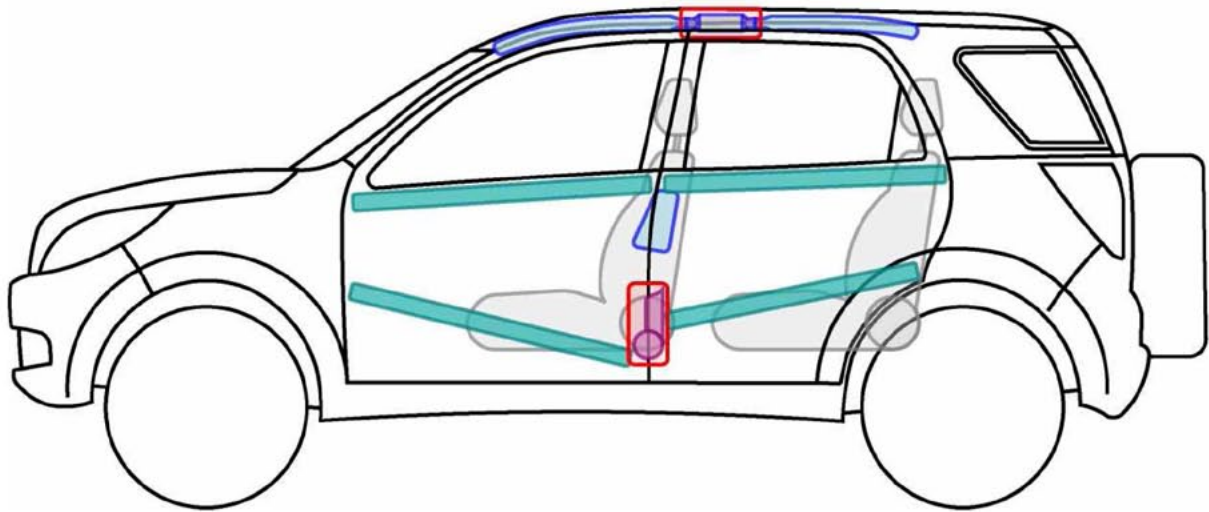
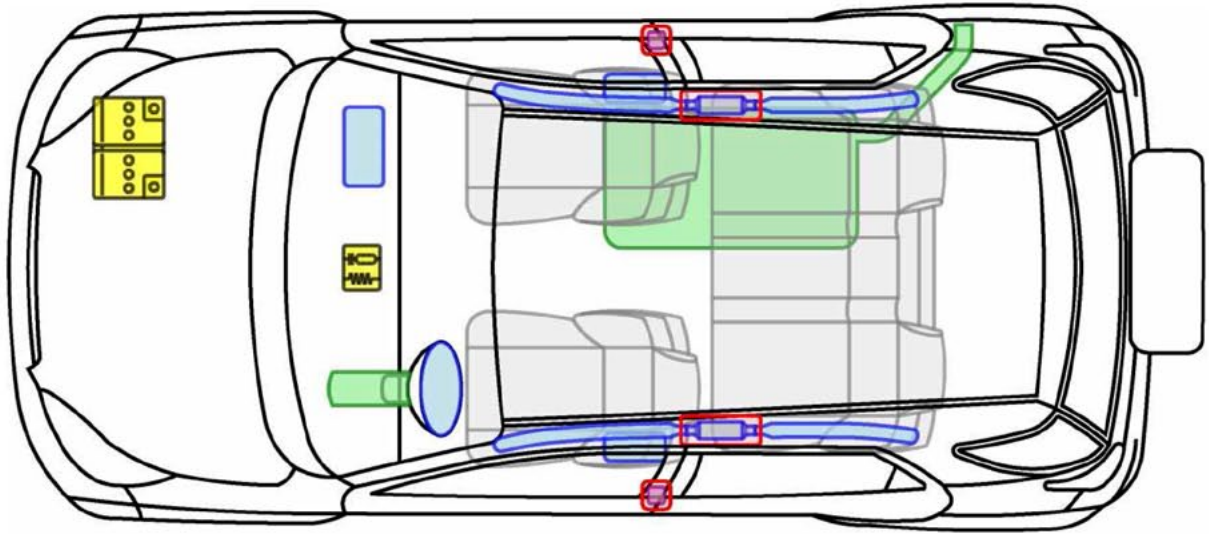

DAIHATSU

MADE IN JAPAN

TERIOS (J2) ab 2006

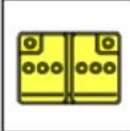

Legende

	Airbag		Karosserie- verstärkung		Steuergerät
	Gas- generator		Überroll- schutz		Batterie
	Gurt- straffer		Gasdruck- dämpfer		Kraftstoff- tank

Terios







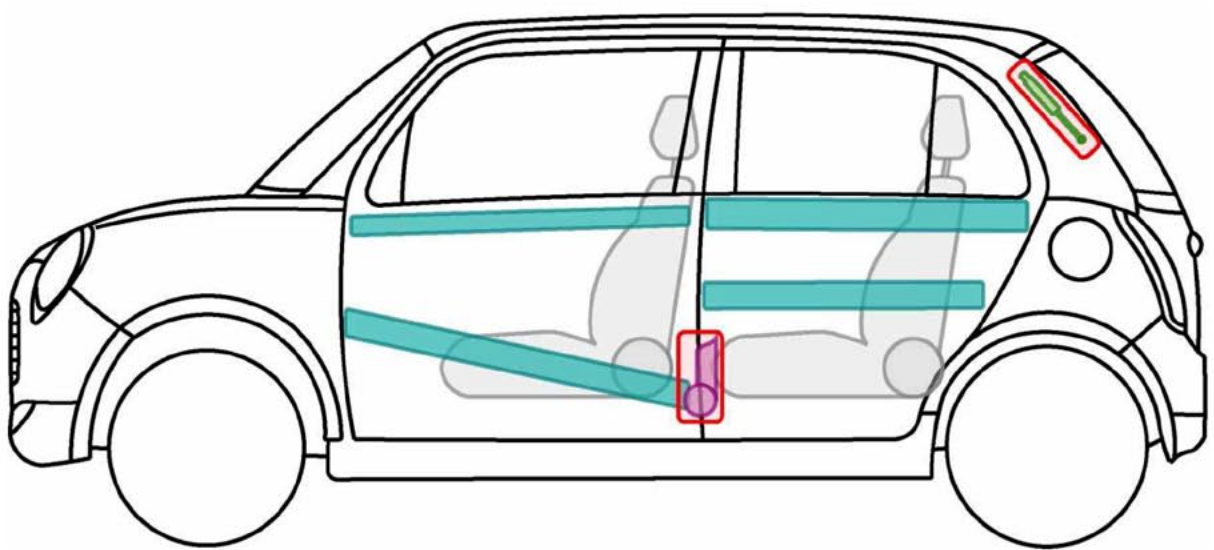
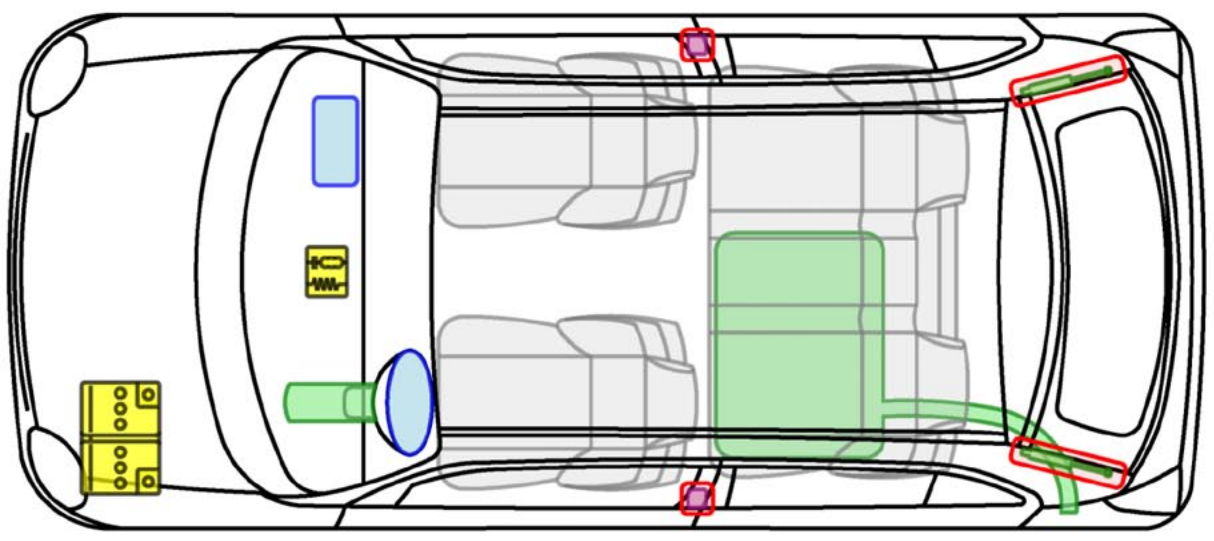

DAIHATSU

MADE IN JAPAN

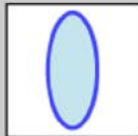
TREVIS (L651) 2006-2009

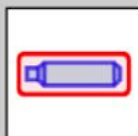

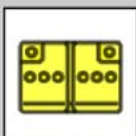
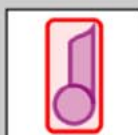
Legende

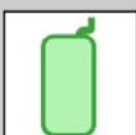
	Airbag		Karosserie- verstärkung		Steuergerät
	Gas- generator		Überroll- schutz		Batterie
	Gurt- straffer		Gasdruck- dämpfer		Kraftstoff- tank

Trevis







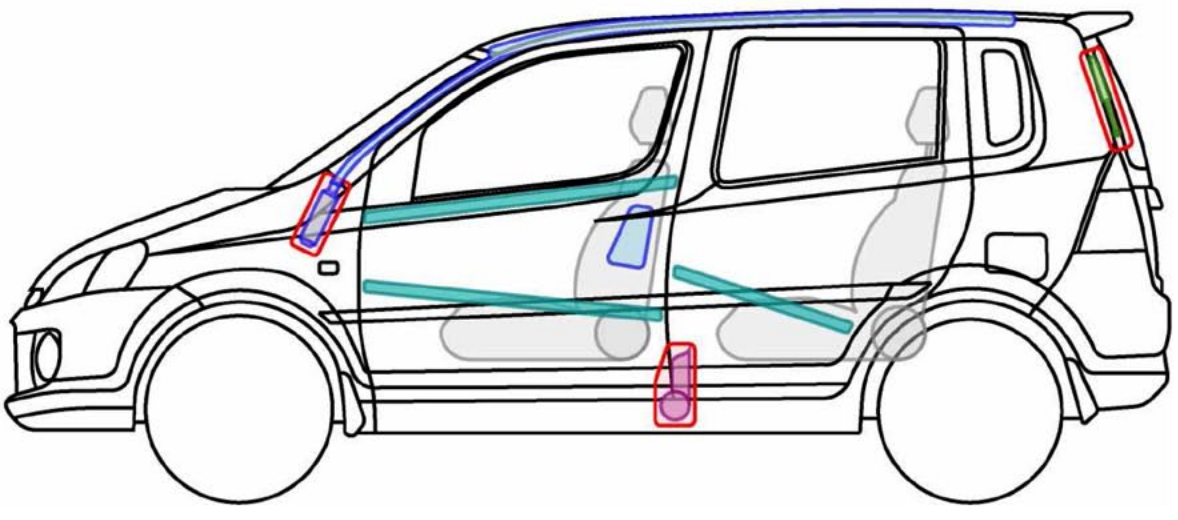
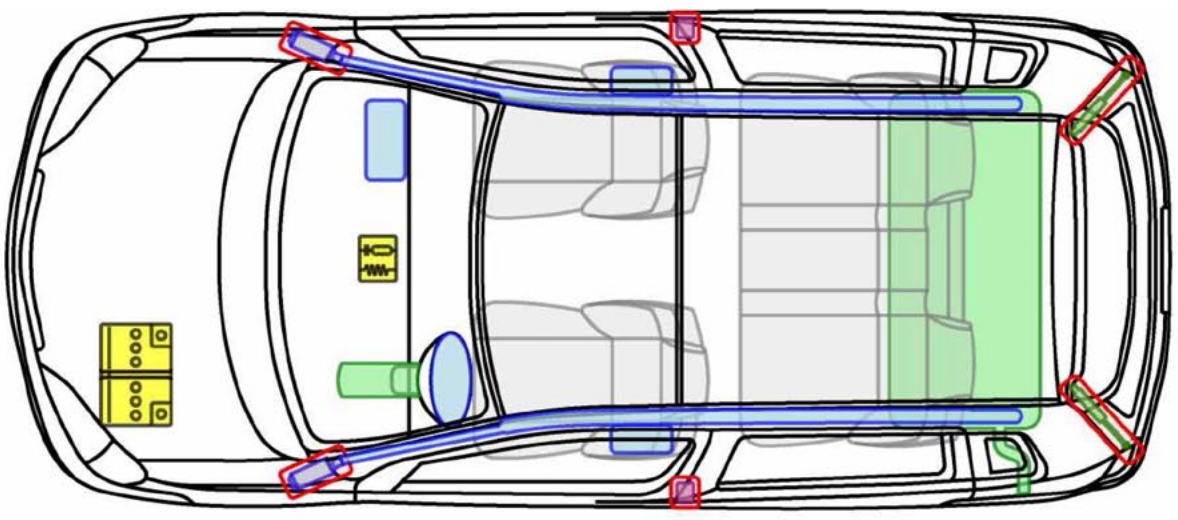

DAIHATSU

MADE IN JAPAN

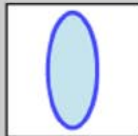
YRV (M2) 2000-2005

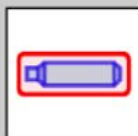

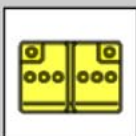
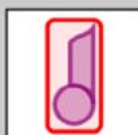
Legende

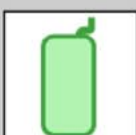
	Airbag		Karosserie- verstärkung		Steuergerät
	Gas- generator		Überroll- schutz		Batterie
	Gurt- straffer		Gasdruck- dämpfer		Kraftstoff- tank

YRV

